

# **USER MANUAL**

## **EARTH RESISTANCE METER**

**MRU-12**



**SET/SEL**

- enter meter settings
- select the digit to change

**Shift/selection**

- right/left
- up/down

**Turning on the meter**

- (press and hold)
- Turning off the meter**  
(press and hold)
- Display backlight**  
(press briefly)

Start the measurement

**ESC**

- return to the previous screen
- exit the function

Approve

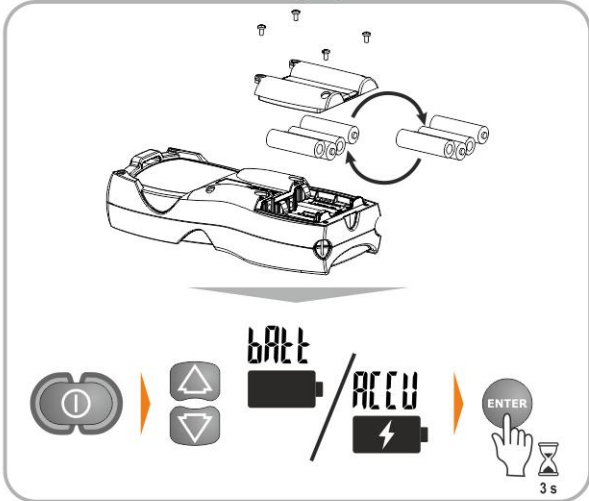

3 s



**USER MANUAL**

**EARTH RESISTANCE METER**  
**MRU-12**



**SONEL S.A.**  
**Wokulskiego 11**  
**58-100 Świdnica**  
**Poland**

Version 1.03 14.05.2026

The MRU-12 meter is a modern, easy and safe measuring device. Please acquaint yourself with this manual in order to avoid measuring errors and prevent possible problems in operation of the meter.

# CONTENTS





<b>1</b>	<b>General information</b>	<b>5</b>
1.1	Safety symbols	5
1.2	Safety	6
<b>2</b>	<b>Quick start</b>	<b>7</b>
2.1	Switching on and off, display backlight	7
2.2	Selecting general measurement parameters	7
2.3	Remembering the last measurement result	7
<b>3</b>	<b>Measurements</b>	<b>10</b>
3.1	Measurement of interference voltages DC + AC	10
3.2	Measurement of earth resistances with 3-pole method ( $R_{E3P}$ )	11
3.3	Measurement of earth resistances with 4-lead method ( $R_{E4P}$ )	15
3.4	Measurement of earth resistances with 2-pole method ( $R_{E2P}$ )	19
3.5	Soil resistivity measurement ( $\rho$ )	21
3.5.1	Wenner method	21
3.5.2	Schlumberger method	22
3.5.3	Measurements	22
<b>4</b>	<b>Memory of measurement results</b>	<b>25</b>
4.1	Entering the measurement results to the memory	25
4.2	Changing the cell and bank number	27
4.3	Browsing the memory	27
4.4	Clearing the memory	28
4.4.1	Clearing the bank	28
4.4.2	Clearing the whole memory	29
4.5	Data transmission	30
4.5.1	Package for cooperation with computer	30
4.5.2	Connection to a computer via Bluetooth module	30
4.5.3	Connection to a mobile device via Bluetooth module	31
<b>5</b>	<b>Software update</b>	<b>32</b>
5.1	Update via update installer	32
5.2	Update via Sonel MeasureEffect mobile app	32
<b>6</b>	<b>Power supply</b>	<b>33</b>
6.1	Monitoring the power supply voltage	33
6.2	Replacing (rechargeable) batteries	34
6.3	General principles regarding using Ni-MH rechargeable batteries	35
<b>7</b>	<b>Cleaning and maintenance</b>	<b>35</b>
<b>8</b>	<b>Storage</b>	<b>35</b>
<b>9</b>	<b>Dismantling and disposal</b>	<b>36</b>
<b>10</b>	<b>Technical data</b>	<b>36</b>
10.1	Basic data	36
10.2	Operating data	38
10.3	Additional data	39
10.3.1	Influence of serial interference voltage on the resistance measurements for function $R_{E3P}$ , $R_{E4P}$ , $\rho$	39

10.3.2 Influence of the auxiliary electrodes on earth resistance measurements for function $R_{E3P}$ , $R_{E4P}$ , $\rho$ .....	39
10.3.3 Additional uncertainties according to EN IEC 61557-5 ( $R_{E3P}$ ) .....	39
<b>11 Manufacturer .....</b>	<b>40</b>

# 1 General information

## 1.1 Safety symbols

Poniższe symbole zostały użyte na przyrządzie i/lub w niniejszej instrukcji:

	Refer to the user manual for additional information and explanations		Double insulation (protection class)		Declaration of Conformity with EU directives (Conformité Européenne)
	Do not dispose of with other household waste		Attention, risk of electric shock		

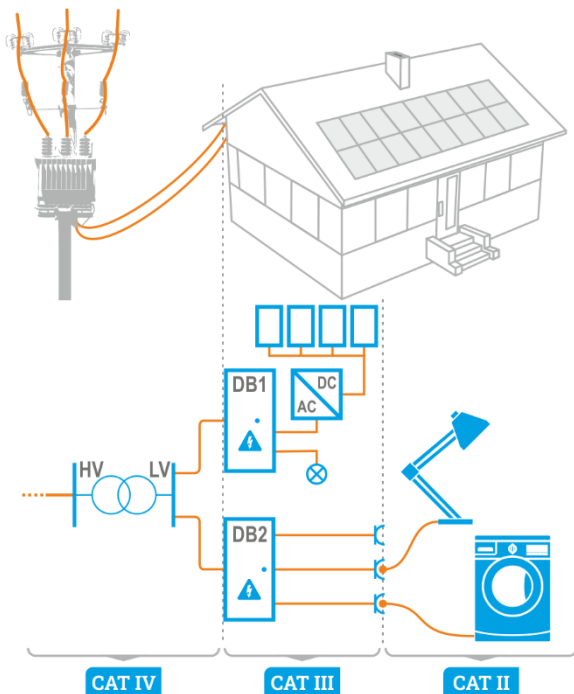

Measurement categories according to EN IEC 61010-2-030:

- **CAT II** – concerns measurements performed in circuits directly connected to low voltage installations,
- **CAT III** – concerns measurements performed in buildings installations,
- **CAT IV** – concerns measurements performed at the source of low voltage installation.

## 1.2 Safety

MRU-12 meter is designed for measuring parameters important for safety of electrical installations. Therefore, in order to provide conditions for correct operation and accuracy of obtained results, the following recommendations must be observed:

- Before you proceed to operate the meter, acquaint yourself thoroughly with the present manual and observe the safety regulations and specifications provided by the producer.
- MRU-12 meter is designed to measure earth resistance and soil resistivity values. Any application that differs from those specified in the present manual may result in a damage to the device and constitute a source of danger for the user.
- The meter must be operated solely by appropriately qualified personnel members holding required certificates for carrying measurements in electric installations. Unauthorized use of the meter may result in its damage and may be a source of serious hazard to the user.
- Using this manual does not exclude the need to comply with occupational health and safety regulations and with other relevant fire regulations required during the performance of a particular type of work. Before starting the work with the device in special environments, e.g. potentially fire-risk/explosive environment, it is necessary to consult it with the person responsible for health and safety.
- It is unacceptable to operate the device when:
  - ⇒ a damaged meter which is completely or partially out of order,
  - ⇒ a meter with damaged insulation,
  - ⇒ a meter stored for an excessive period of time in disadvantageous conditions (e.g. excessive humidity). **If the meter has been transferred from a cool to a warm environment with a high level of relative humidity, do not start measurements until the meter is warmed up to the ambient temperature (approximately 30 minutes).**
- Before measurement make sure that test leads are connected to appropriate measuring terminals.
- Do not power the meter from sources other than those listed in this manual.
- The inputs of the meter are protected electronically against overload e.g. due to having been connected to a live circuit, for all combinations of inputs - up to 276 V for 30 seconds.
- Factory calibration does not include the resistance of the test leads. The result displayed by the meter is a sum of the resistance of the measured object and the resistance of leads.
- The device meets the requirements of standards EN 61010-1 and EN IEC 61557-1, -5.
- The set may contain third-party accessories. Regarding their safe use, the technical documentation of the respective accessory's manufacturer included in the set is binding.



- Due to continuous product development, the manufacturer reserves the right to introduce changes to the functionality, appearance, accessories and technical data of the meter. Due to continuous development of the meter's software, the actual appearance of the display, in case of some of the functions, may slightly differ from the display presented in this operating manual.
- This manual applies to meters with firmware version  $\geq 1.05$ .



## 2 Quick start

### 2.1 Switching on and off, display backlight

To **switch on** and **off** the meter, press and hold the  button (when switched off, the **OFF** message appears).

To switch on/off the display **backlight** during the meter operation, briefly press the  button.

### 2.2 Selecting general measurement parameters

①  +  Keeping the **SET/SEL** button pressed, switch on the meter and wait for the parameter selection screen to appear.





Use the ◀▶ buttons to go to next parameter.



Use the ▲▼ buttons to change the parameter value. The value or symbol to be changed is flashing.

② Set the parameters according to the algorithm.

③  /  Press and hold **ENTER** (until a signal sounds – ca. 3 s) to save the changes and go to the measurement function or press **ESC** to go the measurement function without saving the changes.



- **At first start-up** or **after replacing batteries**, select the type of power supply: rechargeable batteries (ACCU) or batteries (BATT). General measurement parameters can be selected in the same menu.
- PIN settings – see **Meter settings** schematic.
- Software upgrade - see **Meter settings** schematic and **section 4.5**.

### 2.3 Remembering the last measurement result

The result of the last measurement is remembered until the next measurement is activated or the measurement parameters are changed. Use the **ESC** button to go to the starting screen of a given function and press **ENTER** to display the last measurement result.

## Meter settings – algorithm

	$f_N$	DIST	BEEP	OFF	BT
<ul style="list-style-type: none"> <li>▲ 50 Hz</li> <li>▼ 60 Hz</li> </ul>	<ul style="list-style-type: none"> <li>▪ m</li> <li>▪ ft</li> </ul>	<ul style="list-style-type: none"> <li>▪ on</li> <li>▪ off</li> </ul>	<ul style="list-style-type: none"> <li>▪ ---</li> <li>▪ 300 s</li> <li>▪ 600 s</li> <li>▪ 900 s</li> </ul>	<ul style="list-style-type: none"> <li>▪ mem</li> <li>▪ rem</li> <li>▪ off</li> </ul>	
	Mains frequency	Distance unit between auxiliary electrodes	Beeper: enabled / disabled	Auto-OFF <ul style="list-style-type: none"> <li>▪ disabled</li> <li>▪ time to automatic shutdown</li> </ul>	Bluetooth communication: enabled / disabled

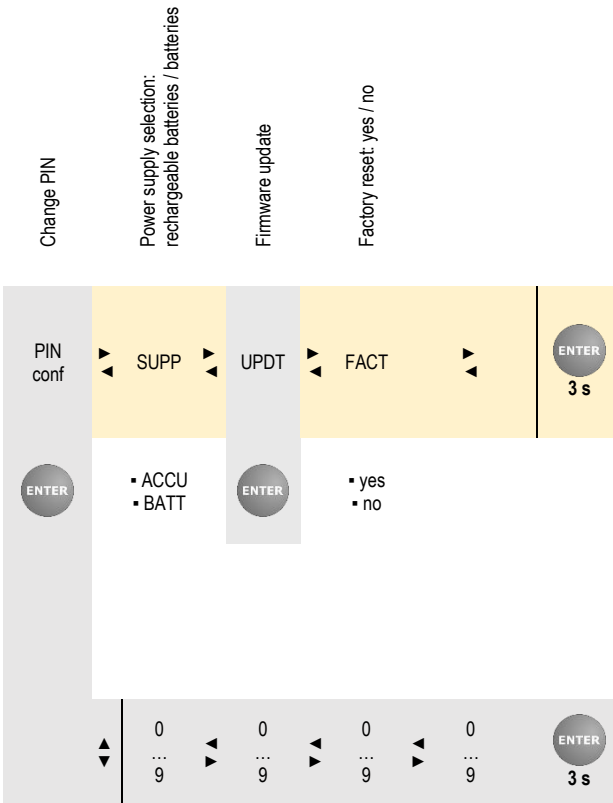

### 3 Measurements

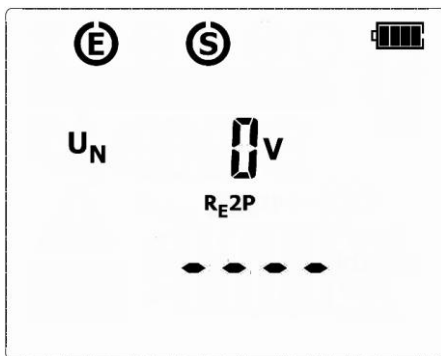

Earth resistance measurements significantly different from other measurements performed to assess the protection against electric shock. They require a thorough knowledge of the structure of the earthing system, the phenomena occurring during the measurements and the skills of coping with adverse outdoor conditions. Earthing system tests/measurements require adequate knowledge and measuring equipment, which will be able to maximally facilitate these examinations.

#### 3.1 Measurement of interference voltages DC + AC





In measuring functions, before **START** button is pressed, the meter monitors the measuring voltage at the terminals (between **E** socket and **S / H** sockets) and the interference voltage value is displayed on the screen.

#### Additional information displayed by the meter

**U<sub>N</sub> >100V!, >100V**  
and a continuous beep ,  
**NOISE!** and 

Voltage at test terminals is higher than 100 V, the measurement is blocked.

**U<sub>N</sub> xxV!, >40V** and a continuous  
beep , **NOISE!** and 

Where xx is the value of interference voltage. Voltage at test terminals is higher than 40 V but lower than 100 V, the measurement is blocked.

**U<sub>N</sub> xxV!, >24V, NOISE!** and 

Where xx is the value of interference voltage. Voltage at test terminals is higher than 24 V but lower than 40 V, the measurement is blocked.

**NOISE!**

The interference voltage is lower than 24 V, but with a high value - the measurement result may be affected by additional uncertainty.

### 3.2 Measurement of earth resistances with 3-pole method ( $R_{E3P}$ )

For earth resistance measurements, the most commonly used method is the 3-pole method, often called the potential drop method, or technical method. During the measurement, the voltage drop at the earthing is measured with current flowing through it, then the Ohm's law is used to calculate the resistance.

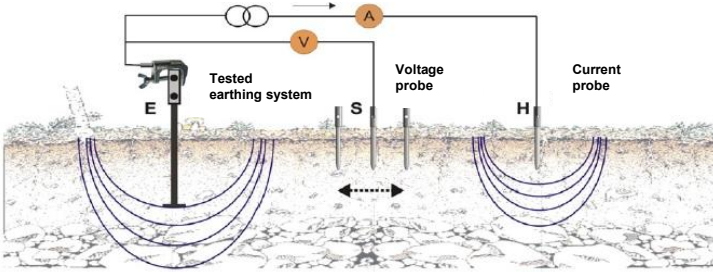

The scheme of measuring the earthing resistance with the 'technical method' is shown above. The figure shows the measurement of earthing resistance  $R_E$ . To perform the measurement, use two additional auxiliary electrodes:

- **H** electrode (current electrode) to allow excitation of current flow in the circuit: tested earth electrode  $R_E \rightarrow$  meter  $\rightarrow$  H current electrode  $\rightarrow$  earth  $\rightarrow$  tested earth electrode;
- **S** electrode (voltage electrode) for measuring the voltage drop across the resistance of the measured earthing as a result of current flow.

- 1 Disconnect the tested earth electrode from the installation of the facility.

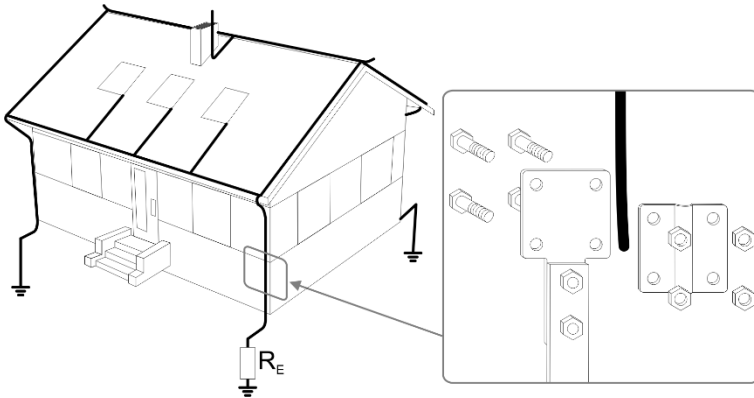

2

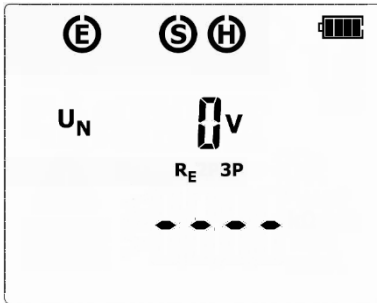

Turn on the meter using **ON/OFF** button.

Using **◀▶** buttons go to **R<sub>E</sub>3P** function.

The meter is in the mode of measuring the interference voltage between the test terminals.

3

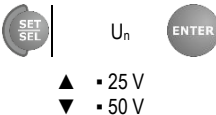

Set the parameters according to the following algorithm and the rules for setting the general parameters.

4

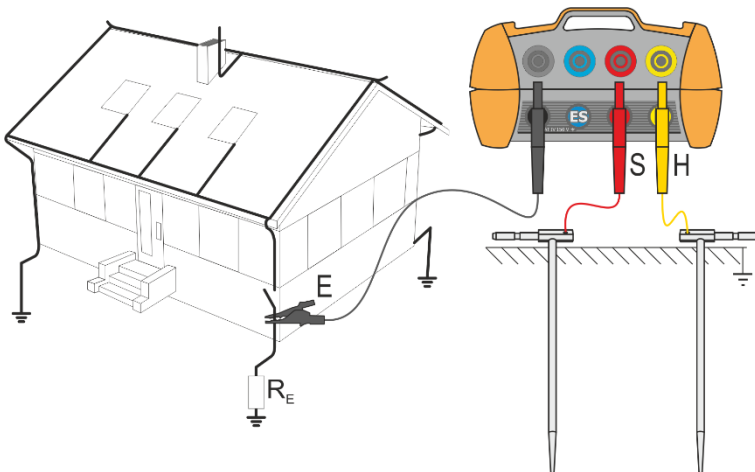

Test leads should be connected to the measurement terminals in the device, as shown above.

- The current electrode **H** (driven into earth) should be connected to **H** socket of the meter.
- The voltage electrode **S** (driven into earth) should be connected to **S** socket of the meter.
- The earth electrode being tested should be connected to **E** socket of the meter with the lead.
- The earth electrode being tested and the current electrode and the voltage electrode should be located in one line.

5



Press **START**.

The progress of the measurement is indicated by horizontal lines on the screen.

6

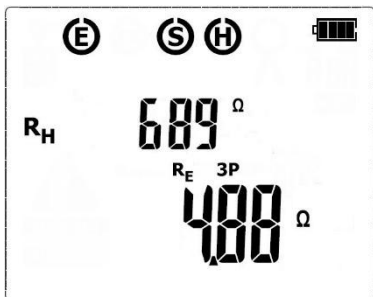

After completing the measurement, results are displayed for all the measurements carried-out: at the bottom of the screen, the main result is shown for  $R_E$ , whereas the upper part of the screen shows additional results for  $R_H$ .

**The result is displayed for 20 seconds.**

The result can be recalled by pressing **ENTER** button.

7

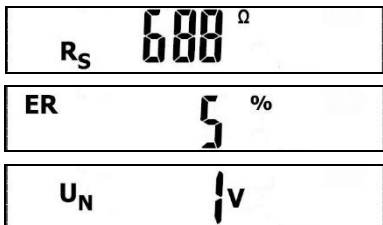

Use  $\blacktriangle$   $\blacktriangledown$  buttons to view the component results:

$R_H$  – resistance of electrode **H**

$R_S$  – resistance of electrode **S**

**ER** – additional uncertainty resulting from the electrode

$U_N$  – interference voltage

8

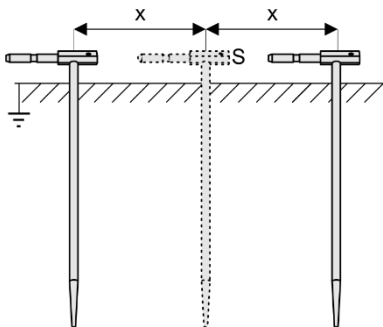

Repeat the measurements (**steps 5, 6, 7**) moving the voltage electrode a few meters - placing it farther and closer to the measured earth electrode.

If  $R_E$  measurement results differ from one another by more than 3%, the distance of the current electrode from the earth electrode being tested should be considerably increased and the measurements should be repeated.









**NOTE!**

Measurement of resistance-to-earth may be carried out if voltage of interferences does not exceed 24 V. Voltage of interferences is measured up to the level of 100 V, but above 40 V it is signalled as dangerous. The meter must not be connected to voltages exceeding 100 V.



- Particular attention should be paid to quality of connection between the object being tested and the test lead – the contact area must be free from paint, rust, etc.
- If resistance of electrodes is too high,  $R_E$  earth electrode measurement will include an additional uncertainty. Particularly high uncertainty of measurement occurs when a small value of resistance-to-earth is measured with electrodes that have a weak contact with earth (such a situation occurs frequently when the earth electrode is well made and the upper soil layer is dry and slightly conductive). In such a case, the ratio of resistance of the electrodes to resistance of the tested earth electrode is very high and consequently, uncertainty of measurement that depends on this ratio is also very high. Then, you can make a calculations according to the formulas given in **sec. 10.3** to estimate the influence of measurement conditions. You can improve the contact between the electrode and soil, for example, by dampening with water the place where the electrode is driven into earth, driving the probe into earth in a different place or using a 80 cm-long electrode. Check also the test leads for possible insulation damage and for corroded or loosened connection between the banana plug and the test lead. In majority of cases the achieved measurement accuracy is satisfactory. However, you should always be aware of the uncertainty included in the measurement.

## Additional information displayed by the meter

$R_E > 9999 \Omega$	Measuring range is exceeded.
$U_N > 100 V, > 100 V$ and a continuous beep  , <b>NOISE!</b> and 	Voltage at test terminals is higher than 100 V, measurement is blocked.
$U_N \text{ xxV}, > 40 V$ and a continuous beep  , <b>NOISE!</b> and 	Where xx is the value of interference voltage. Voltage at test terminals is higher than 40 V, measurement is blocked.
$U_N \text{ xxV}, > 24 V,$ <b>NOISE!</b> and 	Where xx is the value of interference voltage. Voltage at test terminals is higher than 24 V but lower than 40 V, the measurement is blocked.
<b>NOISE!</b>	The interfering signal (noise signal) is too high - the measurement result may be affected by additional uncertainty.
<b>LIMIT!</b> and <b>ER</b> together with the value expressed in %	Measurement due to the resistance of the auxiliary electrodes > 30%. (Measured values are used in calculation of uncertainty.)
<b>LIMIT!</b> and $R_H$ or $R_S$ with the value of $\Omega$	Resistance of auxiliary electrodes H and S, or one of them exceeds 19.9 k $\Omega$ , correct measurement is not possible.
Flashing edges 	Flashing edges of symbols: E or H or S, two or all three at the same time: disconnected one, two or three leads to the terminals, or the resistance of the auxiliary auxiliary electrode/s is outside the measuring range.

### 3.3 Measurement of earth resistances with 4-lead method ( $R_{E4P}$ )

The four-lead method is recommended in the case of measurements of earth resistance of very low values. It permits to eliminate the influence of the test leads resistance over the result of the measurement. In order to evaluate the resistivity of the ground it is recommended to use the dedicated measurement function.

- 1 Disconnect the tested earth electrode from the installation of the facility.

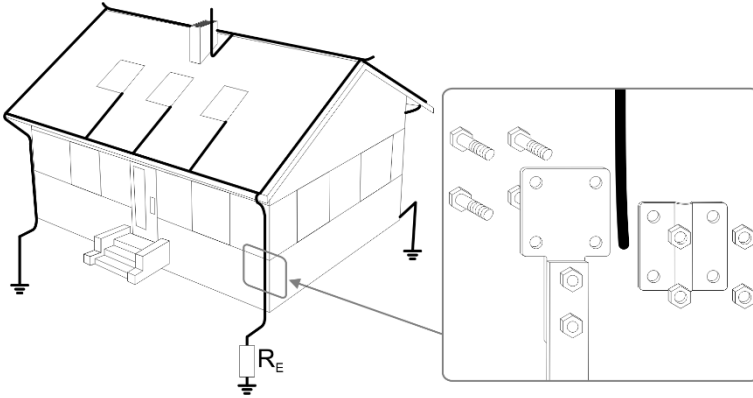

- 2

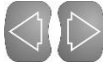

Turn on the meter using **ON/OFF** button.

Using **◀▶** buttons go to  **$R_{E4P}$**  function.

The meter is in the mode of measuring the interference voltage between the test terminals.

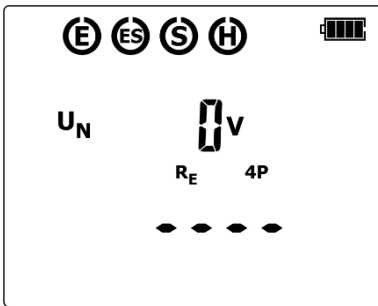

- 3



$U_n$



- ▲ • 25 V
- ▼ • 50 V

Set the parameters according to the following algorithm and the rules for setting the general parameters.

4

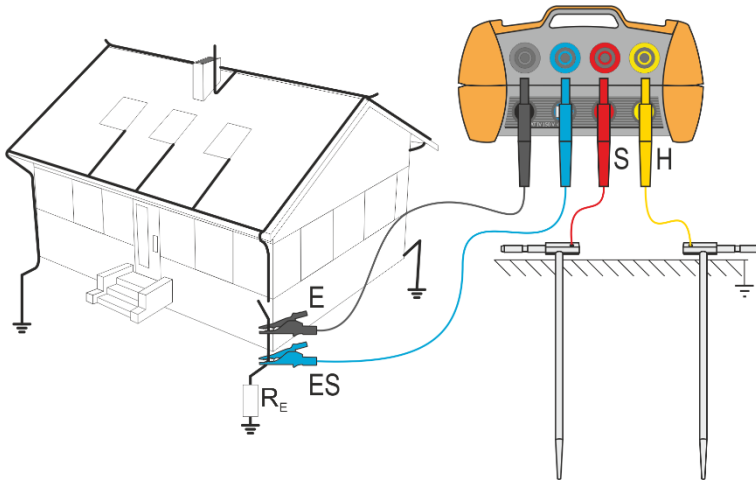

Test leads should be connected to the measurement terminals in the device, as shown above.

- Connect the current electrode driven into ground to the **H** socket of the meter.
- Connect the voltage electrode driven into ground to the **S** socket of the meter.
- Connect the tested earth electrode to the **E** socket of the meter.
- Connect the **ES** socket to the earth electrode In question below the **E** cable.
- The tested earth electrode as well as the current electrode and voltage electrode should be aligned.

5



Press **START**.

The progress of the measurement is indicated by horizontal lines on the screen.

6

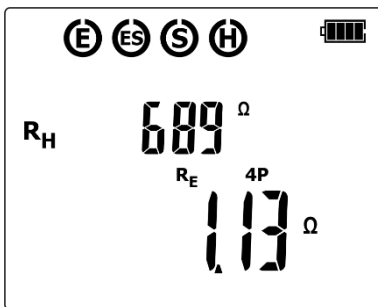

After completing the measurement, results are displayed for all the measurements carried-out: at the bottom of the screen, the main result is shown for  $R_E$ , whereas the upper part of the screen shows additional results for  $R_H$ . **The result is displayed for 20 seconds.** The result can be recalled by pressing **ENTER** button.

7

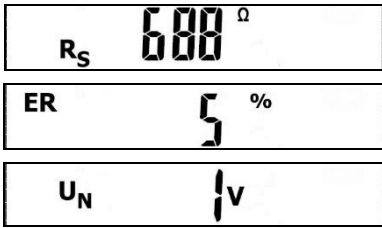

Use ▲▼ buttons to view the component results:

$R_H$  – resistance of electrode H

$R_S$  – resistance of electrode S

$ER$  – additional uncertainty resulting from the electrodes

$U_N$  – interference voltage

8

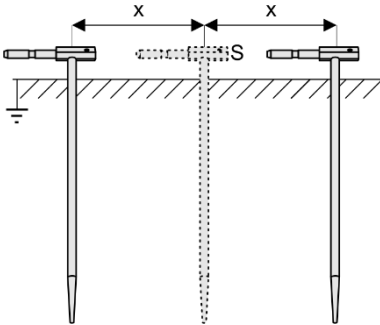

Repeat the measurements (**steps 5, 6, 7**) moving the voltage electrode a few meters - placing it farther and closer to the measured earth electrode.

If  $R_E$  measurement results differ from one another by more than 3%, the distance of the current electrode from the earth electrode being tested should be considerably increased and the measurements should be repeated.











#### NOTE!

Measurement of resistance-to-earth may be carried out if voltage of interferences does not exceed 24 V. Voltage of interferences is measured up to the level of 100 V, but above 40 V it is signalled as dangerous. The meter must not be connected to voltages exceeding 100 V.



- Particular attention should be paid to quality of connection between the object being tested and the test lead – the contact area must be free from paint, rust, etc.
- If resistance of electrodes is too high,  $R_E$  earth electrode measurement will include an additional uncertainty. Particularly high uncertainty of measurement occurs when a small value of resistance-to-earth is measured with electrodes that have a weak contact with earth (such a situation occurs frequently when the earth electrode is well made and the upper soil layer is dry and slightly conductive). In such a case, the ratio of resistance of the electrodes to resistance of the tested earth electrode is very high and consequently, uncertainty of measurement that depends on this ratio is also very high. Then, you can make a calculations according to the formulas given in **sec. 10.3** to estimate the influence of measurement conditions. You can improve the contact between the electrode and soil, for example, by dampening with water the place where the electrode is driven into earth, driving the probe into earth in a different place or using a 80 cm-long electrode. Check also the test leads for possible insulation damage and for corroded or loosened connection between the banana plug and the test lead. In majority of cases the achieved measurement accuracy is satisfactory. However, you should always be aware of the uncertainty included in the measurement.

## Additional information displayed by the meter

$R_E > 9999\Omega$	Measurement range exceeded.
$U_N > 100V, > 100V$ and a continuous sonic signal  , <b>NOISE!</b> and 	The voltage on the measurement points exceeds 100 V, the measurement is blocked.
$U_N \text{ xxV}, > 40V$ and a continuous sonic signal  , <b>NOISE!</b> and 	Where xx is the value of interfering voltage. The voltage on the measurement points exceeds 40 V, the measurement is blocked.
$U_N \text{ xxV}, > 24V, \text{ NOISE!}$ and 	Where xx is the value of interfering voltage. The voltage on the measurement points exceeds 24 V, but it's below 40 V, the measurement is blocked.
<b>NOISE!</b>	The value of the interfering signal is below 24 V, but it has too high value, so the result may be distorted by additional uncertainty.
 and ER along with % value	The uncertainty caused by resistance of the auxiliary elec- trodes > 30%. (Uncertainties calculated on the basis of the measured values.)
 and $R_H$ or $R_S$ along with $\Omega$ value	The resistance of H and S electrodes, or one of them ex- ceeds 19.9 k $\Omega$ , the proper measurement is not possible.
Flashing symbols: 	Flashing symbols E or H or S, or both of them, or all three at the same time, one or two or three test leads are dis- connected from the measurement sockets.

### 3.4 Measurement of earth resistances with 2-pole method ( $R_{E2P}$ )

2-pole method may be also used for measuring earth resistance. When the earthing system is known and earthing is available with a known resistance value, the measurement result will be the sum of the earth resistances: measured and known.

1



Turn on the meter using **ON/OFF** button.

2

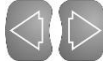

Using **◀▶** buttons go to  **$R_{E2P}$**  function.

The meter is in the mode of measuring the interference voltage between the test terminals.

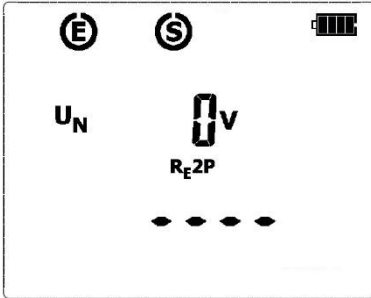

3

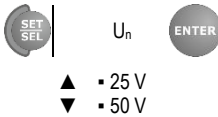

Set the parameters according to the following algorithm and the rules for setting the general parameters.

4

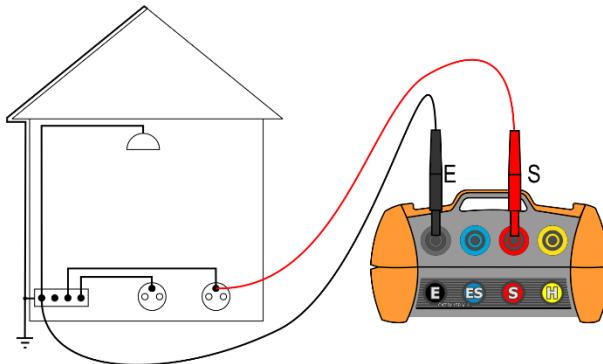

Test leads should be connected to the measurement terminals in the device, as shown above.

5



In order to start the measurement, press **START** button.

6

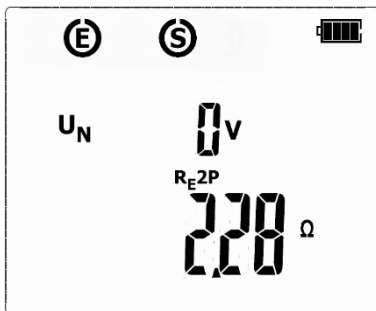



After the measurement, its result is shown: at the bottom of the screen, the main result is shown for **RE2P**, whereas the upper part of the screen shows the measured interference voltage **UN**. **The result is displayed for 20 seconds**. The result can be recalled by pressing **ENTER** button.



### Additional information displayed by the meter

**R > 9999 Ω**

Measuring range is exceeded.

**UN > 100 V, > 100 V** and a continuous beep , **NOISE!** and 

Voltage at test terminals is higher than 100 V, measurement is blocked.

**UN xxV, > 40 V** and a continuous beep , **NOISE!** and 

Where xx is the value of interference voltage. Voltage at test terminals is higher than 40 V, measurement is blocked.

**UN xxV, > 24 V,**  
**NOISE!** and 

Where xx is the value of interference voltage. Voltage at test terminals is higher than 24 V but lower than 40 V, the measurement is blocked.

**NOISE!**

The interfering signal (noise signal) is below 24 V, but with a high value - the measurement result may be affected by additional uncertainty.

### 3.5 Soil resistivity measurement ( $\rho$ )

For the purpose of earth resistivity measurements – which are used as a preliminary measure for the project of earthing systems or in geology - there is a separate function: earth resistivity measurements  $\rho$ . The meter uses the Wenner method and the Schlumberger method.

#### 3.5.1 Wenner method

The function is metrologically identical as the four-lead earth resistance measurement, but it includes an additional procedure of storing of the distance between the auxiliary electrodes. The result of the measurement is the resistance value which is calculated automatically in accordance with the following formula:

$$\rho = 2\pi LR_E$$

The method in question assumes equal  $L$  distances between electrodes.

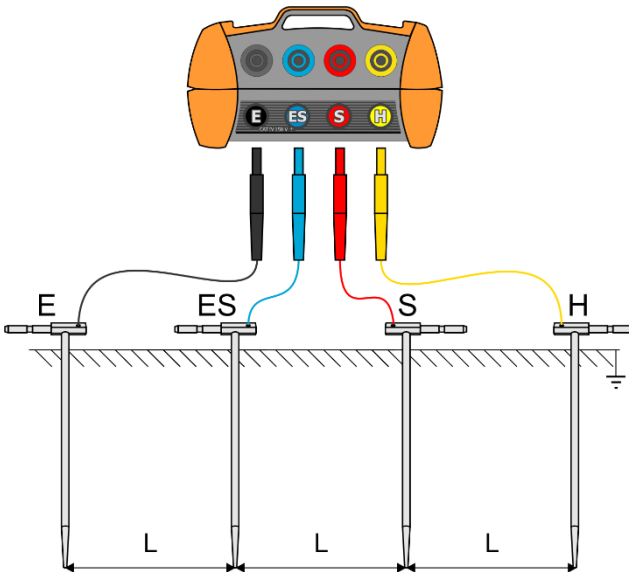

Connect the four aligned and equally spaced auxiliary electrodes, which are driven into the ground, to the meter, and do so in accordance with the diagram.

- Connect the current electrode driven into ground to the **H** socket of the meter.
- Connect the voltage electrode driven into ground to the **S** socket of the meter.
- Connect the voltage electrode driven into ground to the **ES** socket of the meter.
- Connect the current electrode driven into ground to the **E** socket of the meter.

### 3.5.2 Schlumberger method

The result of the measurement is the resistivity value calculated automatically according to the formula:

$$\rho = \frac{\pi A(A+d)}{d} R_E$$

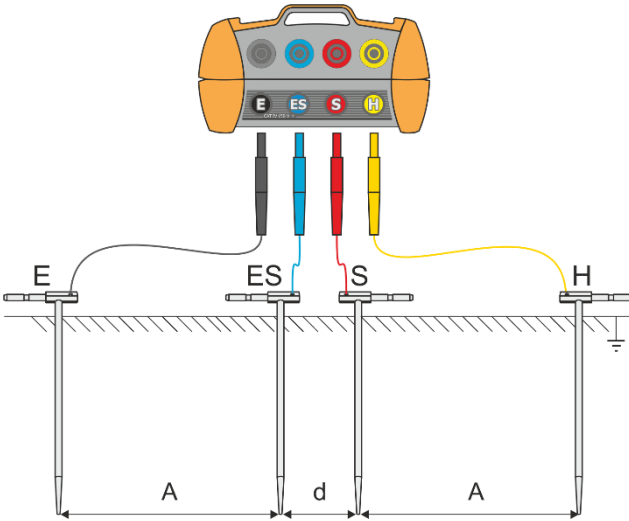

Connect the four aligned auxiliary electrodes, which are driven into the ground, to the meter, and do so in accordance with the diagram. The distance between electrodes E and ES, as well as between S and SH are equal to each other, and at the same time is greater than or equal to 3 times the distance between electrodes ES and S ( $A \geq 3 \cdot d$ ).

- Connect the current electrode driven into ground to the **H** socket of the meter.
- Connect the voltage electrode driven into ground to the **S** socket of the meter.
- Connect the voltage electrode driven into ground to the **ES** socket of the meter.
- Connect the current electrode driven into ground to the **E** socket of the meter.

### 3.5.3 Measurements

1 Connect the measuring system according to **sec. 3.5.1** or **sec. 3.5.2**.



Turn on the meter using **ON/OFF** button.

Using **◀▶** buttons go to  $\rho$  function.

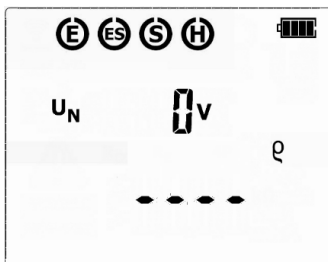

- 3 Set the parameters according to the following algorithm and the rules for setting the general parameters.



$U_n$ ▲ 25 V ▼ 50 V	◀ ▶ Measurement method • L – Wenner method • A d – Schlumberger method	◀ ▶ Distance between auxiliary electrodes • 1 m (Wenner) / 3 m (Schlumberger) • ... • 50 m
---------------------------	---	--



- 4



Press **START** to commence measurement.

- 5

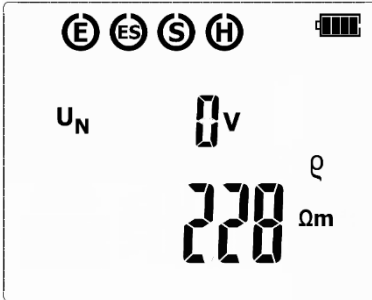

After finishing the measurement, read out the result. The results of all the measurements that have been carried out will be displayed on screen.

- 6

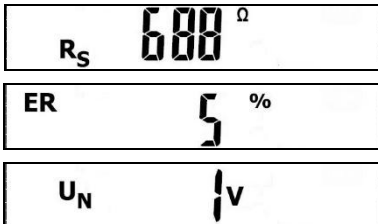

Use ▲ ▼ buttons to view the component results:

$R_H$  – resistance of current electrode  
 $R_S$  – resistance of voltage electrode  
 $ER$  – additional uncertainty caused by the resistance of the electrodes  
 $U_N$  – interfering (noise) voltage









**NOTE!**

Earth resistivity measurement may be performed if the interference voltage does not exceed 24 V. The interference voltage is measured up to 100 V, but over 40 V is it signaled as hazardous. Do not connect the meter to a voltage exceeding 100 V.



- Pay particular attention to the quality of the connection of the tested object with the test leads – the contact area must be cleaned of paint, rust, etc.
- If resistance of electrodes is too high,  $R_E$  earth electrode measurement will include an additional uncertainty. Particularly high uncertainty of measurement occurs when a small value of resistance-to-earth is measured with electrodes that have a weak contact with earth (such a situation occurs frequently when the earth electrode is well made and the upper soil layer is dry and slightly conductive). In such a case, the ratio of resistance of the electrodes to resistance of the tested earth electrode is very high and consequently, uncertainty of measurement that depends on this ratio is also very high. Then, you can make a calculations according to the formulas given in **sec. 10.3** to estimate the influence of measurement conditions. You can improve the contact between the electrode and soil, for example, by dampening with water the place where the electrode is driven into earth, driving the probe into earth in a different place or using a 80 cm-long electrode. Check also the test leads for possible insulation damage and for corroded or loosened connection between the banana plug and the test lead. In majority of cases the achieved measurement accuracy is satisfactory. However, you should always be aware of the uncertainty included in the measurement.

## Additional information displayed by the meter

$\varrho > xxxk\Omega m$ or $\varrho > xxxk\Omega ft$	Measurement range exceeded, where xxx is maximum value that can be measured for the selected settings.
$U_N > 100V, > 100V$ and a continuous sonic signal  ,	The voltage on the measurement points exceeds 100 V, the measurement is blocked.
<b>NOISE!</b> and 	
$U_N xxV, > 40V$ and a continuous sonic signal  ,	Where xx is the value of interfering voltage. The voltage on the measurement points exceeds 40 V, the measurement is blocked.
<b>NOISE!</b> and 	
$U_N xxV, > 24V, \text{NOISE!}$ and 	Where xx is the value of interfering voltage. The voltage on the measurement points exceeds 24 V, but it's below 40 V, the measurement is blocked.
<b>NOISE!</b>	The value of the interfering signal is below 24 V, but it has too high value, so the result may be distorted by additional uncertainty.
<b>LIMIT!</b> and ER along with % value	The uncertainty caused by resistance of the auxiliary electrodes >30%. (Uncertainties calculated on the basis of the measured values.)
<b>LIMIT!</b> and $R_H$ or $R_S$ along with $\Omega$ value	The resistance of H and S electrodes, or one of them exceeds 19.9 k $\Omega$ , the proper measurement is not possible.
Flashing symbols: 	Flashing symbols E or ES or H or S, or two of them, or three, or all of them at the same time – one or two or three or four test leads are disconnected from the measurement sockets.

## 4 Memory of measurement results

The memory is divided into 10 banks with 99 cells each. Due to dynamic memory allocation, each cell can contain a different number of individual results, depending on the needs. This ensures optimum memory use. Each result can be saved in a cell of a specified number and in a chosen bank, thus allowing the user to assign the cell numbers to measurement points, and the bank numbers to tested facilities, make the measurement in any sequence and repeat the measurements without losing other data.

The memory of measurement results is **not cleared** when the meter is switched off. The data can be read later or transmitted to a computer. The number of the current cell and bank is not changed, either.



- After each entry of measurement result to a cell, the cell number is automatically increased.
- Only the results of measurements activated with the **START** button can be entered to the memory.
- It is recommended to clear the memory after reading the data or before a new series of measurements.

### 4.1 Entering the measurement results to the memory

①



After the measurement, press **ENTER**.

②



The meter is in the memory enter mode. Select the bank and cell number acc. To **section 4.2** or leave the current ones.

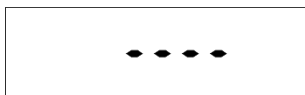

Cell is empty.

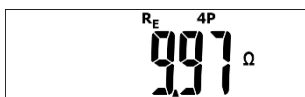

Cell includes a result.

③



Confirm by pressing **ENTER**.

4

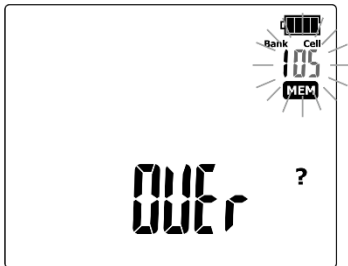

An attempt to overwrite the results triggers the warning message.



Press **ENTER** to overwrite the result or **ESC** to abort.

5

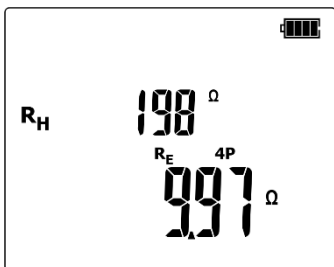

The screen shown left appears for a moment accompanied by three short audio signals. Then, the meter again displays the last measurement result.



The saved data include a complete set of results (main and additional) for a given measurement function plus the set measurement parameters.

## 4.2 Changing the cell and bank number

①

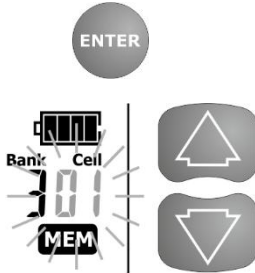

After the measurement, press **ENTER**. The meter is in the memory enter mode.

The cell number is flashing.

Use the ▲ ▼ arrows to change the cell number.

②

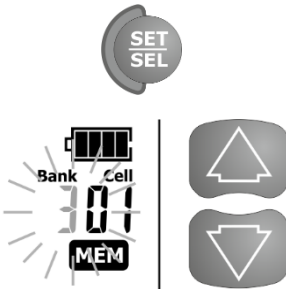

Use the **SET/SEL** button to set the active (flashing) cell or bank number.

The bank number is flashing.

Use the ▲ ▼ arrows to change the bank number.

## 4.3 Browsing the memory

①



- Switch on the meter.
- Using ◀▶ buttons go to **MEM** screen.

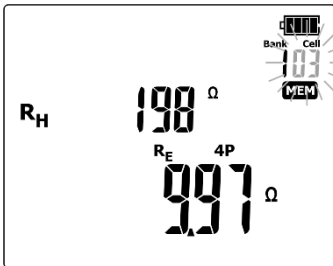

The content of last saved cell is displayed.

The cell number is flashing.

The bank and cell number which you wish to browse is changed with the **SET/SEL** button and then with the ▲ ▼ arrows. If the cell/ bank number is flashing, it can be changed.

## 4.4 Clearing the memory

### 4.4.1 Clearing the bank

1

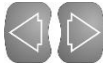

- Switch on the meter.
- Using ◀▶ buttons go to **MEM** screen.

2

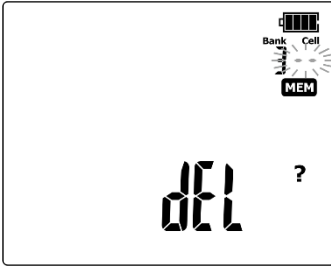

Set the number of bank to be cleared as described in **sec. 4.2**.

Set the cell number to ●● (before 1). The **del** message appears, signaling that the meter is ready to delete.

3



Press **ENTER**. The **Conf** and **!** symbols appear, requiring confirmation.

4

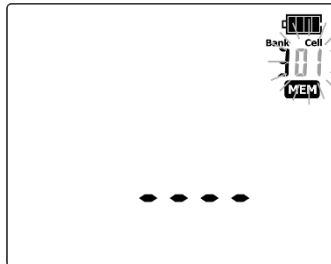

Press **ENTER** to start deleting or **ESC** to abort.

The deletion progress is shown on the screen as scrolling cell numbers. When deletion is completed, the meter generates three short audio signals and sets the cell number to 1.

## 4.4.2 Clearing the whole memory

1



- Switch on the meter.
- Using ◀▶ buttons go to **MEM** screen.

2

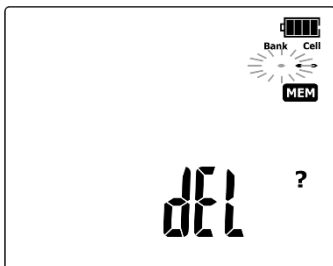

Set the bank number to ◀ (before 0). The **del** message appears, signaling that the meter is ready to delete.

3



Press **ENTER**. The **Conf** and ⚠ symbols appear, requiring confirmation.

4

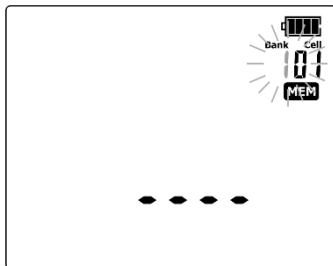

Press **ENTER** to start deleting or **ESC** to abort.

The deletion progress is shown on the screen as scrolling bank and cell numbers. When deletion is completed, the meter generates three short audio signals and sets the cell number to 1.

## 4.5 Data transmission







### 4.5.1 Package for cooperation with computer

In order to ensure the communication of the meter with a computer, additional Bluetooth module and software is required. A program that may be used for this purpose is **Sonel Reader**. It allows users to read and display the measurement data stored in the meter memory. This program may be downloaded free from the manufacturer's website. Information on the availability of other programs cooperating with the meter may be obtained from the manufacturer or its authorized distributors.

The software may be used for many devices manufactured by SONEL S.A. which are equipped with the USB interface and/or wireless module.

Detailed information regarding software is available from the manufacturer or an authorized distributor.







### 4.5.2 Connection to a computer via Bluetooth module

- 1  +  Keeping the **SET/SEL** button pressed, switch on the meter and wait for the parameter selection screen to appear (see **sec. 2.2**).
- 2  Using buttons ◀▶ go to parameter **BT**.
- 3  Using buttons ▲▼ select **mem** or **rem**.
- 4  Press and hold **ENTER** to save the changes. From now on the symbol  will be visible on the screen.
- 5 Connect Bluetooth module to the USB socket of the PC, unless it is integrated into the PC.
- 6 Pair the meter with the computer. To do this, add this meter in the computer's Bluetooth menu and enter the PIN code consistent with the PIN code in the meter's main settings.
- 7 On the computer start **Sonel Reader**.

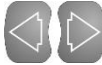

- Standard PIN for Bluetooth is **1234**. Settings in the meter according to **section 2.2**.
- During communication and data transfer, the  symbol blinks.

### 4.5.3 Connection to a mobile device via Bluetooth module

- 1  +  Keeping the **SET/SEL** button pressed, switch on the meter and wait for the parameter selection screen to appear (see **sec. 2.2**).
- 2  Using buttons ◀▶ go to parameter **BT**.
- 3  Using buttons ▲▼ select **mem** or **rem**.
- 4  Press and hold **ENTER** to save the changes. From now on the symbol  will be visible on the screen.
- 5 Pair the meter with the computer. To do this, add this meter in the computer's Bluetooth menu and enter the PIN code consistent with the PIN code in the meter's main settings.
- 6 Install the **Sonel MeasureEffect Connect** application on the mobile device.
- 7 Install and run the **Sonel MeasureEffect** application on the mobile device.



- Standard PIN for Bluetooth is **1234**. Settings in the meter according to **section 2.2**.
- During communication and data transfer, the  symbol blinks.

## 5 Software update













### 5.1 Update via update installer

- 1 Download the update installer from the manufacturer's website.
- 2 Install the update installer on the computer.
- 3 Pair the meter with the computer. To do this, add this meter in the computer's Bluetooth menu and enter the PIN code consistent with the PIN code in the meter's main settings.
- 4 Run the update installer and follow the on-screen messages.

### 5.2 Update via Sonel MeasureEffect mobile app



Update via the application is possible for meters with firmware  $\geq 1.05$ .

- 1  Connect the meter to the mobile app acc. to **sec. 4.5.3**.
- 2    In the application, go to the **Folders** section, select „Add new”, and then select the icon for downloading data from the meter. The message „Enable update mode on the meter” will appear.
- 3  Without closing the „Enable update mode on the meter” message, turn off the meter.
- 4  +  Keeping the **SET/SEL** button pressed, switch on the meter and wait for the parameter selection screen to appear (see **sec. 2.2**).
- 5  Using buttons   go to parameter **UPDT**.
- 6  Press and hold **ENTER** to confirm the start of the update. A progress bar will appear in the app; you can now close the update requirement message. When the progress bar reaches 99%, the meter will turn off automatically.
- 7  Switch on the meter.
- 8  The update progress bar in the application will reach 100% and disappear, replaced by a message stating the update is complete. Close the message window. The meter is ready to send data to the app.

## 6 Power supply

Before the measurements, make sure that the status of the batteries or rechargeable batteries in the meter is sufficient for performing tasks related to the operation of the device.

### 6.1 Monitoring the power supply voltage

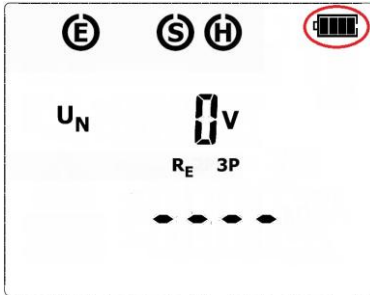

The charge level of the batteries or rechargeable batteries is indicated by the symbol in the right upper corner of the display on a current basis:



When all segments of the battery symbol are lit, it means that the batteries/rechargeable batteries are fully charged.



When all segments of the battery symbol are dark, it means that the batteries/rechargeable batteries are discharged and must be replaced.



Message **bAtt** indicates that batteries/rechargeable batteries are totally discharged, all measurements are blocked. The meter switches off automatically after 5 sec.

## 6.2 Replacing (rechargeable) batteries

MRU-12 is powered by four AA alkaline LR6 batteries or rechargeable batteries of NiMH type. The (rechargeable) batteries are placed in the compartment at the bottom of the enclosure. The device is not equipped with an internal battery charger. Rechargeable batteries must be recharged in an external charger.



### NOTE!

Do not power the meter from sources other than those listed in this manual. Before replacing the (rechargeable) batteries, disconnect the test leads from the meter.

1

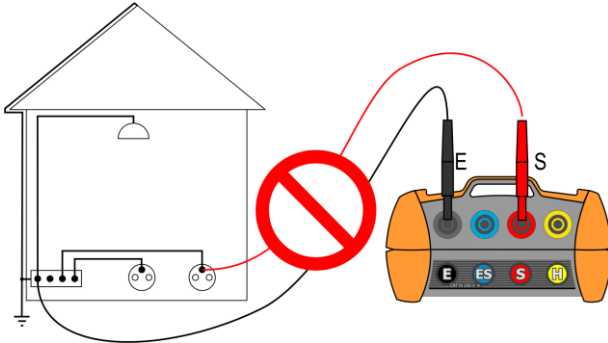

Disconnect the unit from the object!

2



Turn off the device using **ON/OFF** button.

3

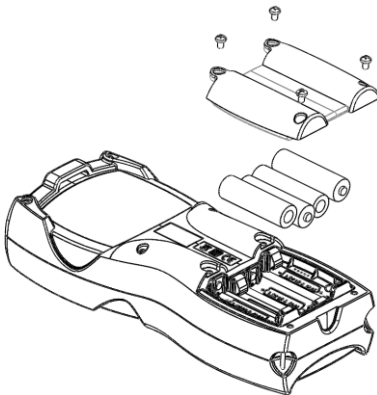

Remove the screws that secure the battery cover at the bottom of the compartment(4 pcs),

Remove all batteries (rechargeable batteries). Observe the correct polarity when inserting new batteries/rechargeable batteries.

Place and tighten the battery compartment cover.



- Reverse polarity will not damage the meter or the batteries, but the meter will not work.
- After replacement of batteries, **set the power supply type in the main menu** because correct charging level indication depends on this. Discharging characteristics of batteries and rechargeable batteries are different.
- Have the meter serviced in case of battery leakage inside the compartment.

## 6.3 General principles regarding using Ni-MH rechargeable batteries

- Store the rechargeable batteries (the meter) in a dry, cool and well ventilated place and protect them from direct sunlight. The temperature of the environment in the case of prolonged storage should not exceed 30°C. If the rechargeable batteries are stored for a long time in a high temperature, then the occurring chemical processes may reduce their lifetime.
- Rechargeable batteries NiMH usually lasts for 500-1000 charging cycles. The rechargeable batteries reach their maximum capacity after being formatted (2-3 charge and discharge cycles). The most important factor which influences the lifetime of rechargeable batteries is the level of their discharge. The deeper the discharge level of the batteries, the shorter their lifetime.
- The memory effect is limited in the case of NiMH batteries. These batteries may be charged at any point with no serious consequences. However, it is recommended to discharge them completely every few cycles.
- During storage of Ni-MH rechargeable batteries they are discharged at the rate of approximately 20% per month. Keeping rechargeable batteries at high temperatures may accelerate this process even 100%. In order to prevent excessive discharge of rechargeable batteries, after which it would be necessary to format them, it is recommended to charge them from time to time (even if they are not used).
- Modern fast chargers detect both too low and too high temperature of the battery pack and react to the situation adequately. Too low temperature should prevent starting the process of charging, which might irreparably damage rechargeable batteries. An increase of the temperature of the rechargeable batteries is a signal to stop charging and is a typical phenomenon. However charging at a high ambient temperature apart from reducing batteries' lifetime causes an accelerated increase of their temperature and the result is that the batteries are not charged to their full capacity.
- Please note that when the batteries are charged with a fast-charger they are charged only to approx. 80% of their capacity - better results can be achieved by continuing charging: the charger enters trickle-charging mode and during the next few hours batteries are charged to their full capacity.
- Do not charge or use the batteries in extreme temperatures. Extreme temperatures reduce the lifetime of batteries and rechargeable batteries. Avoid placing devices powered by rechargeable batteries in very hot environments. The nominal working temperature must be absolutely observed.

## 7 Cleaning and maintenance



### NOTE!

Use only the maintenance methods specified by the manufacturer in this manual.

The casing of the meter may be cleaned with a soft, damp cloth using all-purpose detergents. Do not use any solvents or cleaning agents which might scratch the casing (powders, pastes, etc.).

Clean the auxiliary electrode with water and dry it. Before the probe is stored for a prolonged period of time it is recommended to grease it with any machine lubricant.

The reels and test leads should be cleaned with water and detergents, and then dried.

The electronic system of the meter does not require maintenance.

## 8 Storage

In the case of storage of the device, the following recommendations must be observed:

- Disconnect all the test leads from the meter.
- Clean the meter and all its accessories thoroughly.
- Wind the long test leads onto the reels.
- If meter is to be stored for a prolonged period of time, the batteries must be removed from the device.
- In order to prevent a total discharge of the battery pack in the case of a prolonged storage, charge it from time to time.

## 9 Dismantling and disposal

Worn-out electric and electronic equipment should be gathered selectively, i.e. it must not be placed with waste of another kind.

Worn-out electronic equipment should be sent to a collection point in accordance with the law of waste electrical and electronic equipment.

Before the equipment is sent to a collection point, do not dismantle any elements.

Observe local regulations concerning disposal of packages, waste batteries and accumulators.

## 10 Technical data

- The specified accuracy relates to the meter terminals.
- The abbreviation „m.v.” in the accuracy definition means the measured value.

### 10.1 Basic data

#### Measurement of interference voltage $U_N$ (RMS)

Range	Resolution	Accuracy
0...100 V	1 V	$\pm(10\% \text{ m.v.} + 1 \text{ digit})$

- Measurement for  $f_N$  45...65 Hz.
- The frequency of measurement - at least 2 measurements / sec.

#### Measurement of earth resistances – 2-pole method ( $R_{E2P}$ )

Range	Resolution	Accuracy
0.01 $\Omega$ ... 19.99 $\Omega$	0.01 $\Omega$	$\pm(3\% \text{ m.v.} + 3 \text{ digits})$
20.0 $\Omega$ ...199.9 $\Omega$	0.1 $\Omega$	
200 $\Omega$ ...1999 $\Omega$	1 $\Omega$	$\pm 5\%$
2000 $\Omega$ ...9999 $\Omega$	1 $\Omega$	$\pm 8\%$

- Measuring current at the short circuit of  $> 20 \text{ mA}$ .
- Measuring frequency of 125 Hz or 150 Hz.
- Selected test voltage: 25 V or 50 V.
- Maximum interference voltage for the  $R_E$  measurement is 24 V.

#### Measurement of earth resistances – 3-pole method ( $R_{E3P}$ ), 4-wire method ( $R_{E4P}$ )

Measurement method: 3-pole, conforming to EN IEC 61557-5.

Measurement range according to EN IEC 61557-5: 0.53  $\Omega$ ...9999  $\Omega$  for  $U_n = 50 \text{ V}$ .

Range	Resolution	Accuracy
0.00 $\Omega$ ...19.99 $\Omega$	0.01 $\Omega$	$\pm(3\% \text{ m.v.} + 3 \text{ digits})$
20.0 $\Omega$ ...199.9 $\Omega$	0.1 $\Omega$	
200 $\Omega$ ...1999 $\Omega$	1 $\Omega$	$\pm 5\%$
2000 $\Omega$ ...9999 $\Omega$	1 $\Omega$	$\pm 8\%$

- Measuring current at the short circuit of  $> 20 \text{ mA}$ .
- Measuring frequency of 125 Hz or 150 Hz.
- Selected test voltage: 25 V or 50 V.
- Maximum interference voltage for the  $R_E$  measurement is 24 V.

### Ground resistivity measurements

The measurement method: Wenner's,  $\rho = 2\pi LR_E$

Range	Resolution	Accuracy
0.00..9.99 $\Omega$ m	0.01 $\Omega$ m	Depends on the accuracy of the $R_E$ 4P measurement but not less than $\pm 1$ digit.
10.0..99.9 $\Omega$ m	0.1 $\Omega$ m	
100..999 $\Omega$ m	1 $\Omega$ m	
1.00..9.99 k $\Omega$ m	0.01 k $\Omega$ m	
10.0..99.9 k $\Omega$ m	0.1 k $\Omega$ m	
100..999 k $\Omega$ m	1 k $\Omega$ m	

- distance between auxiliary electrodes (L): 1...50 m or 1...150 ft

The measurement method: Schlumberger's,  $\rho = \frac{\pi A(A+d)}{d} R_E$

Range	Resolution	Accuracy
0.00..9.99 $\Omega$ m	0.01 $\Omega$ m	Depends on the accuracy of the $R_E$ 4P measurement but not less than $\pm 1$ digit.
10.0..99.9 $\Omega$ m	0.1 $\Omega$ m	
100..999 $\Omega$ m	1 $\Omega$ m	
1.00..9.99 k $\Omega$ m	0.01 k $\Omega$ m	
10.0..99.9 k $\Omega$ m	0.1 k $\Omega$ m	
100..999 k $\Omega$ m	1 k $\Omega$ m	

- distance between auxiliary electrodes (A): 3....50 m or 3...150 ft

### Measurement of resistance of auxiliary electrodes $R_H$ and $R_S$

Range	Resolution	Accuracy
0...999 $\Omega$	1 $\Omega$	$\pm(5\% + 8 \text{ digits})$
1.00...9.99 k $\Omega$	0.01 k $\Omega$	
10.0...19.9 k $\Omega$	0.1 k $\Omega$	

## 10.2 Operating data

a)	type of insulation acc. to EN 61010-1 and IEC IEC 61557	double
b)	measurement category (for 2000 m a.s.l.) acc. to EN 61010-1	III 300 V
c)	degree of housing protection acc. to EN 60529	IP65
d)	maximum interference of AC + DC voltages, for the measurement	24 V
e)	maximum measured voltage of interferences	100 V
f)	measuring current frequency	125 Hz for 50 Hz networks 150 Hz for 60 Hz networks
g)	measuring voltage for $R_{E2P}$ , $R_{E3P}$ , $R_{E4P}$ , $\rho$	25 V or 50 V
h)	measuring current (short circuit) for $R_{E2P}$ , $R_{E3P}$ , $R_{E4P}$ , $\rho$	>20 mA
i)	measurement range according to EN IEC 61557-5:	0.53 $\Omega$ ...9999 $\Omega$ for $U_n = 50$ V
j)	maximum resistance of auxiliary electrodes	20 k $\Omega$
k)	meter power supply	4 x AA alkaline battery 4 x AA NiMH rechargeable battery
l)	number of measurements for $R_{E3P}$	>2000
	( $R_E=10$ $\Omega$ , $R_H=R_S=100$ $\Omega$ , 25 V 50 Hz, 2 measurements/minute, Bluetooth disabled)	
m)	time of performing the resistance measurement with:	
	▪ 2-pole method ( $R_{E2P}$ )	<4 s
	▪ 3-pole method ( $R_{E3P}$ )	<8 s
	▪ 4-lead method ( $R_{E4P}$ )	<8 s
n)	dimensions	221 x 102 x 62 mm
o)	weight of the meter with batteries	710 g
p)	operating temperature	-10°C...+50°C
q)	reference temperature	23 $\pm$ 2°C
r)	storage temperature	-20...+60°C
s)	relative humidity	20...90%
t)	nominal relative humidity	40...60%
u)	altitude (above sea level)	$\leq$ 2000 m*
v)	time to Auto-OFF	300, 600, 900 seconds or none
w)	display	LCD segment
x)	measurement results memory	990 cells
y)	transmission of results	Bluetooth
z)	quality standard	design and manufacturing are ISO 9001 compliant
aa)	measurement method	technical, conforming to EN IEC 61557-5
bb)	the device meets the EMC requirements according to	EN IEC 61326-1 and EN IEC 61326-2-2



SONEL S.A. hereby declares that the radio device type MRU-12 complies with Directive 2014/53/EU. The full text of the EU Declaration of Conformity is available at the following website address: <https://sonel.pl/en/download/declaration-of-conformity/>

### NOTE

#### \* Information about the use of meter at altitude from 2000 m to 5000 m

As for voltage inputs E, ES, S, H the instrument is to be considered downgraded to measurement category CAT III 150 V to ground (max 150 V between inputs) or CAT IV 100 V to ground (max 100 V between inputs). Markings and symbols indicated on the instrument are to be considered valid when using it at altitude lower than 2000 m.

### 10.3 Additional data

Data on additional uncertainties are useful mainly when the meter is used in non-standard conditions and for metrological laboratories for the purpose of calibration.

#### 10.3.1 Influence of serial interference voltage on the resistance measurements for function $R_E3P$ , $R_E4P$ , $\rho$

$R_E$	$U_N$	Additional uncertainty [ $\Omega$ ]
0.00 ... 10.00 $\Omega$	25 V	$\pm(0.001R_E+0.01)U_z+0.007U_z^2$
	50 V	$\pm(0.001R_E+0.01)U_z+0.004U_z^2$
10.01..2000 $\Omega$	25 V, 50 V	$\pm(0.001R_E+0.01)U_z+0.001U_z^2$
2001..9999 $\Omega$	25 V, 50 V	$\pm(0.003R_E + 0.4)U_z$

#### 10.3.2 Influence of the auxiliary electrodes on earth resistance measurements for function $R_E3P$ , $R_E4P$ , $\rho$

$R_H, R_S$	Additional uncertainty [%]
$R_H \leq 5 \text{ k}\Omega$ and $R_S \leq 5 \text{ k}\Omega$	$\pm \left( \frac{R_S}{R_S + 100000} \cdot 150 + \frac{R_H \cdot 0.004}{R_E} + 1.5 \cdot 10^{-8} \cdot R_H^2 \right)$
$R_H > 5 \text{ k}\Omega$ or $R_S > 5 \text{ k}\Omega$ or $R_H$ and $R_S > 5 \text{ k}\Omega$	$\pm \left( 7.5 + \frac{R_H \cdot 0.004}{R_E} + 1.5 \cdot 10^{-8} \cdot R_H^2 \right)$

$R_E[\Omega]$ ,  $R_S[\Omega]$  and  $R_H[\Omega]$  are values displayed by the device.

#### 10.3.3 Additional uncertainties according to EN IEC 61557-5 ( $R_E3P$ )

Significant parameter	Designation	Additional uncertainty
Position	$E_1$	0%
Supply voltage	$E_2$	0% ( <b>BAT</b> is not lit)
Temperature	$E_3$	$\pm 0.2 \text{ digit}/^\circ\text{C}$ for $R < 1 \text{ k}\Omega$ $\pm 0.07\%/^\circ\text{C} \pm 0.2 \text{ digit}/^\circ\text{C}$ for $R \geq 1 \text{ k}\Omega$
Serial interference voltage	$E_4$	According to the formulas shown in par. 9.2.1 ( $U_N=3\text{V } 50/60\text{Hz}$ )
Resistance of earth contact probes	$E_5$	According to the formula in par. 9.3.2

## 11 Manufacturer

The manufacturer of the device and provider of guarantee and post-guarantee service:

**SONEL S.A.**

Wokulskiego 11

58-100 Świdnica

Poland

tel. +48 74 884 10 53 (Customer Service)

e-mail: [customerservice@sonel.com](mailto:customerservice@sonel.com)

web page: [www.sonel.com](http://www.sonel.com)



### NOTE!

Service repairs must be performed only by the manufacturer.





**SONEL S.A.**

Wokulskiego 11  
58-100 Świdnica  
Poland

**Customer Service**

tel. +48 74 884 10 53  
e-mail: [customerservice@sonel.com](mailto:customerservice@sonel.com)

[www.sonel.com](http://www.sonel.com)